

Using MEDIVATORS® ADVANTAGE® Automated Endoscope Reprocessors

ADVANTAGE HOOKUP DIAGRAM

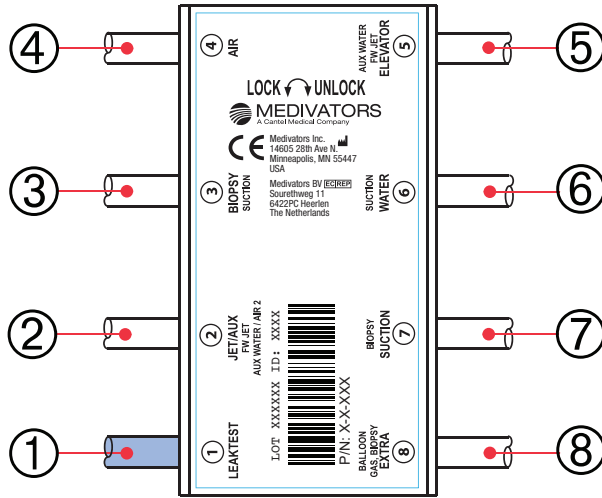

Each ADVANTAGE Hookup is comprised of multiple ports and connector assemblies. Each port is labeled with a Port ID number (circled). This same number also identifies the corresponding Connector Assembly.

CONNECTOR ASSEMBLY IDENTIFICATION CHART

| Port ID | Port Name | Connector Assembly Description  | Order Number |
|---------|-----------|---------------------------------|--------------|
| ①       | LEAK TEST | Leak Test Connector Assembly    | H28335-1     |
| ②       | JET/AUX   | NA                              | NA           |
| ③       | BIOPSY    | Biopsy Inlet Connector Assembly | H28335-3     |
| ④       | AIR       | NA                              | NA           |
| ⑤       | ELEVATOR  | NA                              | NA           |
| ⑥       | WATER     | NA                              | NA           |
| ⑦       | SUCTION   | Suction Connector Assembly      | H28335-7     |
| ⑧       | EXTRA     | Balloon Connector Assembly      | H28335-8     |

If a Connector Assembly needs replacement, locate the port number/name and use the corresponding order number found in the chart above. Connector Assemblies are specific to individual hookups.

If you have any questions regarding this hookup, in the U.S., please contact MEDIVATORS Technical Support at 1-800-444-4729. Outside the U.S., please contact your MEDIVATORS Distributor.

Locate the endoscope port and follow the instructions for attaching the corresponding Endoscope Connector. All connectors must be attached.

Suction Connector

Align and insert the end of the connector into the suction valve port. Firmly push the connector until it "clicks", then push the "LOCK" button until there is another "click". To remove, press the "RELEASE" latch. (Make sure the "LOCK" button pops up.) Tilt the connector towards the v-notch of the scope port while pulling the connector out.

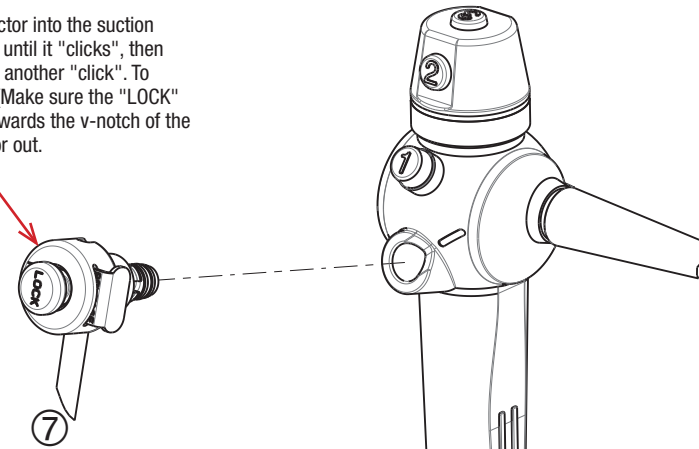

Biopsy Connector

Align the biopsy connector disc over the biopsy inlet and push down to compress spring and slide the frame forward to fully engage.

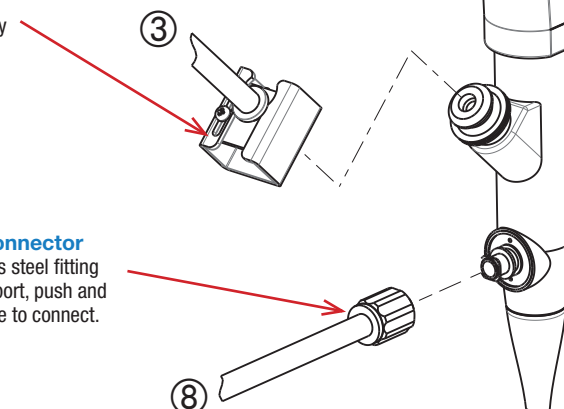

Balloon Connector

Align stainless steel fitting with balloon port, push and turn clockwise to connect.

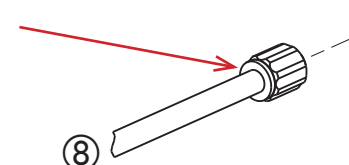

Leak Test Connector

Align the slot on connector with the pin on the waterproof cap. Push on and turn clockwise to engage.

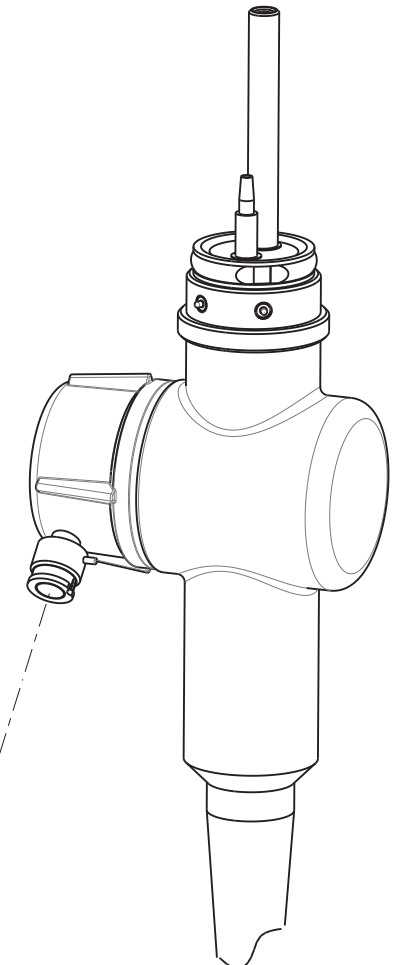
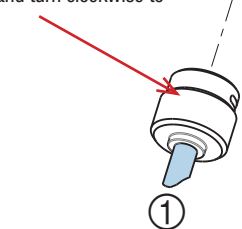

DESIGNATED HOOKUP FOR THE FOLLOWING OLYMPUS® ENDOSCOPES\*:

- BF-UC160AL5 BF-UC160F-OL8 BF-U180F BF-UC180F-A BF-UC180F-Q BF-UC2 BF-UC260F-OL8 BF-UC40P-1 BF-UM40

\* This list of corresponding endoscope models is subject to change without notice. For a full list, please go to:

[www.medivators.com/hookuplookup](http://www.medivators.com/hookuplookup)

Representative endoscope for illustrative purposes only. For exact port locations, refer to endoscope manufacturer's instruction guide.

## HOOKUP CONNECTOR BLOCK LABEL

The Hookup Connector Block Label contains useful information for quick reference.

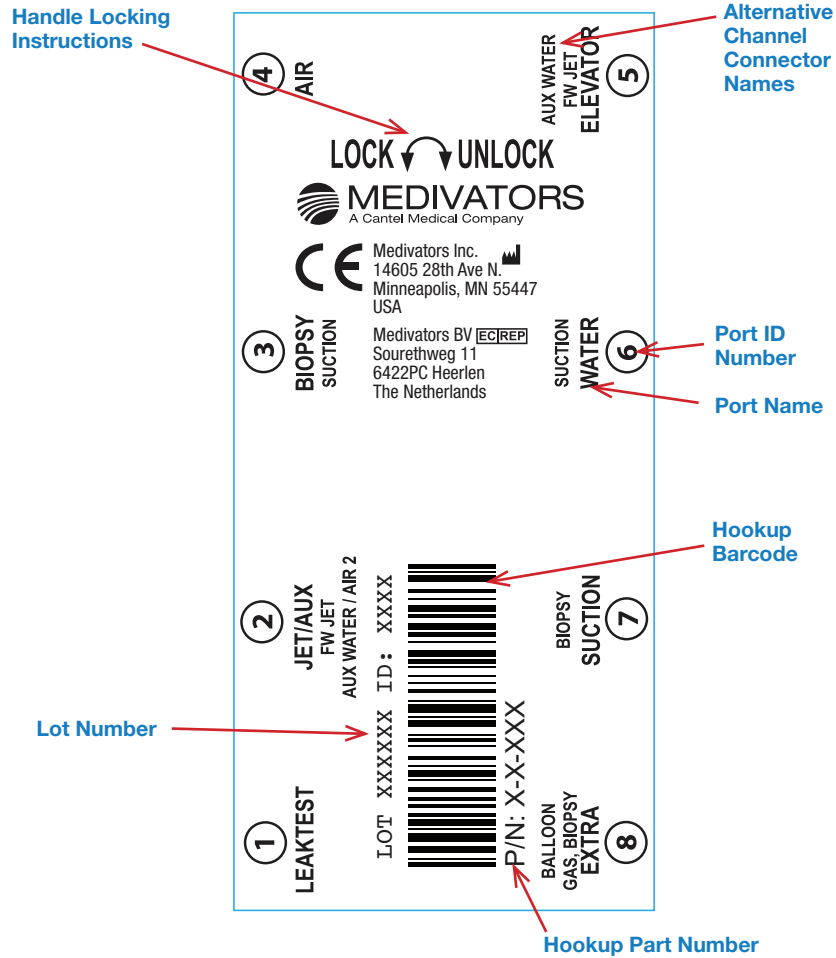

**Handle Locking Instructions** - insert block onto basin channel manifold and move handle to the left to lock. Move to the right to unlock.

**Lot Number** - identifies date of manufacture.

**Hookup Part Number** - identifies hookup.

**Hookup Barcode** - barcode of part number.

**Port Name** - identifier of port location in ADVANTAGE system. Error logs identify issues using these names. Also identifier of Connector Assembly replacements for older model hookups.

**Port ID Number** - identifier for Connector Assembly replacements. Not found on older model hookups.

**Alternative Channel Connector Names** - connector names vary depending on specific endoscope channel configuration.

## WARNINGS & CAUTIONS



This hookup is intended for connection only with the specific endoscope models identified in the appropriate MEDIVATORS online hookup guide. Use of this hookup with endoscopes other than those specified by the hookup application guide may result in inadequate HLD.

Users operating MEDIVATORS AERs and hookups must be trained and competent in the understanding of endoscope channel systems.

Prior to reprocessing, users must verify that the hookup used contains connections for all appropriate channels that require a separate reprocessing connection according to the hookup instructions

All connectors and adapters must remain firmly attached and unrestricted for the entire disinfection cycle to ensure adequate HLD. Users must inspect the endoscope and hookup combination to verify proper connection and flow.

Modifications or repairs to hookups which do not correspond to the manufacturer's specifications may result in inadequate HLD and/or damage to endoscopes.

Failure to properly clean and prepare endoscope for immersion prior to hookup connection may result in inadequate HLD and/or damage to the endoscope.

Endoscopes must be inspected for damage and verified to be in proper working order prior to hookup connection. Connection of hookups to damaged endoscopes or endoscopes with obstructed/restricted channels could result in inadequate HLD.

Manual leak testing must be carried out in accordance with manufacturer's recommendations prior to reprocessing.

Install all necessary waterproof caps, plugs and cleaning adapters prior to immersion.

Do NOT autoclave MEDIVATORS hookups.

MEDIVATORS makes no claim on high-level disinfection efficacy when these reprocessing instructions are not followed, or when this hookup kit is applied to endoscopes other than those specified in the online interactive hookup guide.

Avoid biological contamination. Always wear personal protective equipment when handling endoscopes.



Manufactured in the USA by:

Medivators Inc.  
14605 28th Avenue North  
Minneapolis, MN 55447 USA  
Toll Free: +1.800.444.4729



Medivators BV  
Sourethweg 11  
6422PC Heerlen  
The Netherlands  
Tel: +31.45.5.471.471



Cantel Medical Asia/Pacific Pte. Ltd.  
1A International Business Park  
#05-01 Singapore 609933  
Tel: +65.6227.9698

Cantel Medical Devices (China) Co. Ltd.  
Unit 804-805, Innov Tower Block A,  
Hongmei Road, Xuhui 200233 Shanghai  
Tel: +86 21 60161380  
Fax: +86 21 61210913

[www.medivators.com](http://www.medivators.com)