

2-8-119HAN/2-8-119CAS HOOKUP CONNECTOR ASSEMBLY REPLACEMENT INSTRUCTIONS

For use with MEDIVATORS® ADVANTAGE® Automated Endoscope Reprocessors

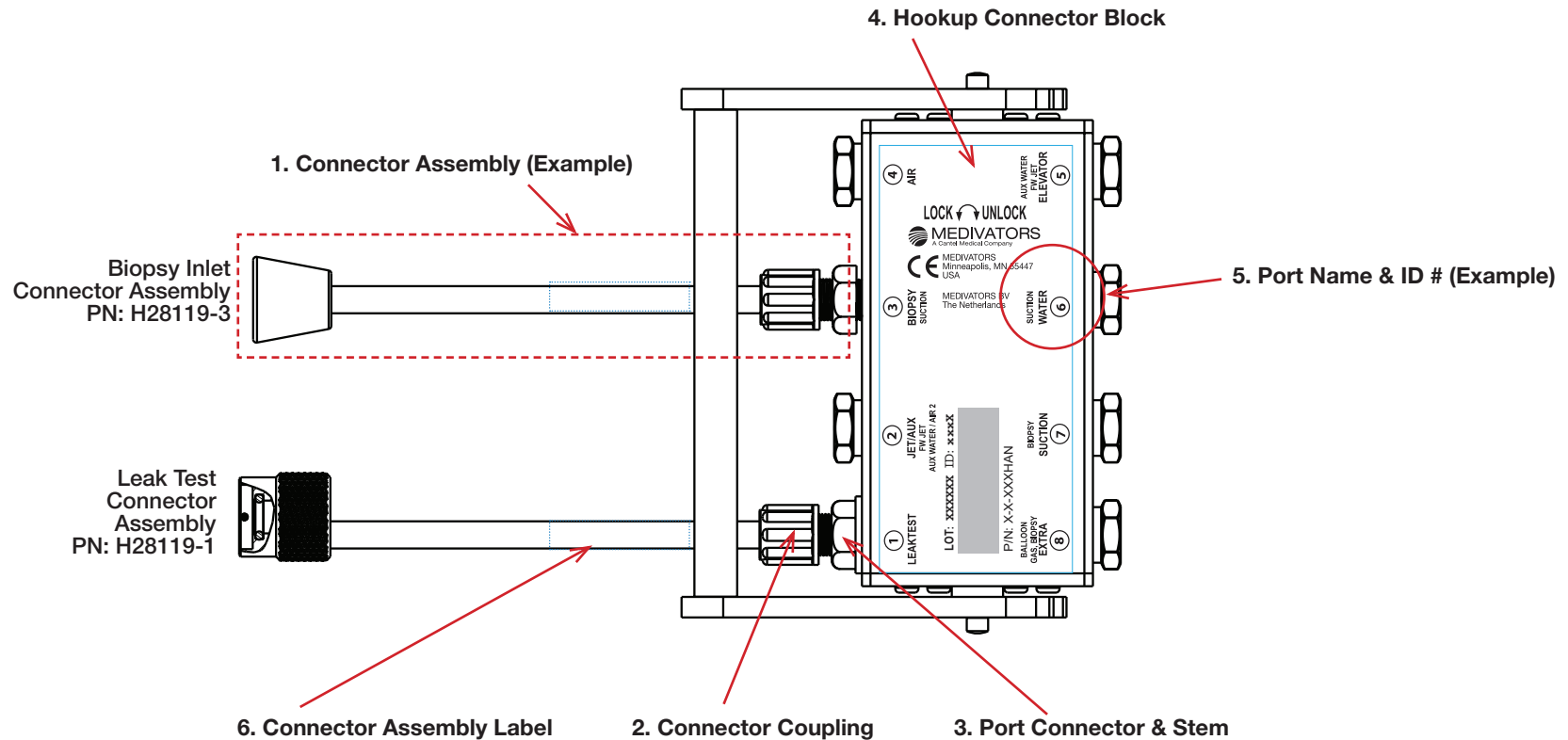

Directions for replacement of Connector Assemblies:

1. Identify current Connector Assembly on Hookup Connector Block to be replaced. See Connector Assembly 1 for example.
2. Remove current Connector Assembly by first unscrewing Connector Coupling 2 of Connector Assembly from Port Connector 3, keeping Port Connector firmly held in place.
3. Pull tubing off Port Connector stem 3. Discard this Connector Assembly.
4. Retrieve enclosed new Connector Assembly. Confirm Connector Assembly labeling matches Hook-up Connector Block Label Port Name and Port ID Number 5. NOTE: Port ID # may not be identified on some older Hookup Connector Block Labels.
5. Push tubing of new Connector Assembly onto Port Connector Stem 3.
6. Manually screw Connector Coupling 2 onto Port Connector 3 until tight. Do not force tighten. Ensure Port Connector 3 does not turn. If needed, use wrench to prevent turning.

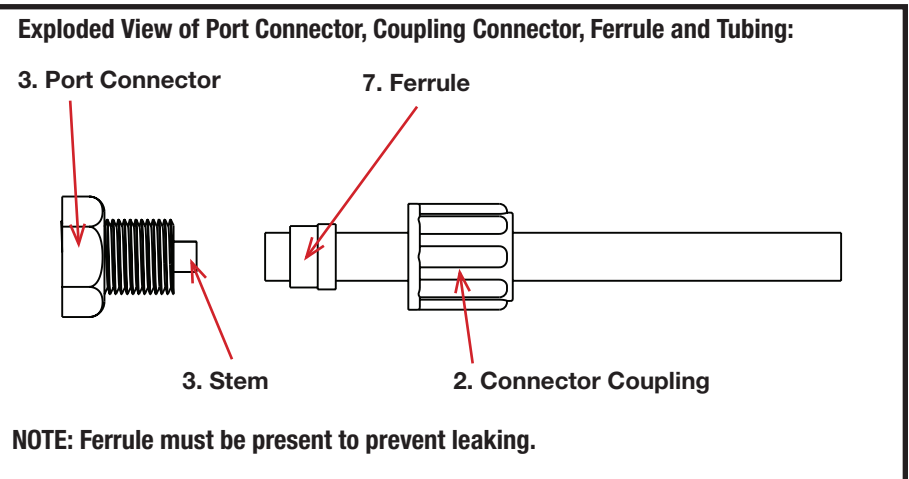

WARNINGS & CAUTIONS



This hookup is intended for connection only with the specific endoscope models identified in the appropriate MEDIVATORS online hookup guide. Use of this hookup with endoscopes other than those specified by the online hookup guide may result in inadequate HLD.

Users operating MEDIVATORS AERs and hookups must be trained and competent in the understanding of endoscope channel systems.

Prior to reprocessing, users must verify that the hookup used contains connections for all appropriate channels that require a separate reprocessing connection according to the hookup instructions.

All connectors and adapters must remain firmly attached and unrestricted for the entire disinfection cycle to ensure adequate HLD. Users must inspect the endoscope and hookup combination to verify proper connection and flow.

Modifications or repairs to hookups which do not correspond to the manufacturer's specifications may result in inadequate HLD and/or damage to endoscopes.

Failure to properly clean and prepare endoscope for immersion prior to hookup connection may result in inadequate HLD and/or damage to the endoscope.

Endoscopes must be inspected for damage and verified to be in proper working order prior to hookup connection. Connection of hookups to damaged endoscopes or endoscopes with obstructed/restricted channels could result in inadequate HLD.

Manual leak testing must be carried out in accordance with manufacturer's recommendations prior to reprocessing.

Install all necessary waterproof caps, plugs and cleaning adapters prior to immersion.

Do NOT autoclave MEDIVATORS hookups.

MEDIVATORS makes no claim on high-level disinfection efficacy when these reprocessing instructions are not followed, or when this hookup kit is applied to endoscopes other than those specified in the online interactive hookup guide.

Avoid biological contamination. Always wear personal protective equipment when handling endoscopes.

HOOKUP CONNECTOR BLOCK LABEL - PORT INFORMATION

Port ID	Port Name	Alternative Channel Connector Names
1	LEAK TEST	Leak Test
2	JET/AUX	Forward Water Jet, Auxiliary Water, Air
3	BIOPSY	Biopsy Inlet, Suction
4	AIR	Air Probe
5	ELEVATOR	Elevator Wire, Auxiliary Water, Forward Water Jet
6	WATER	Water, Suction
7	SUCTION	Suction, Biopsy
8	EXTRA	Biopsy, Gas, Balloon

CONNECTOR ASSEMBLY LABEL (example)

PORT NUMBER:	1
PART NUMBER:	H28XXX-1
PORT NAME:	LEAK TEST
HOOKUP PART NUMBER:	2-8-XXX HAN/CAS
LOT #:	LOT#: XXXXXX
BRAND:	MEDIVATORS

If you have any questions regarding this hookup, in the U.S., please contact MEDIVATORS Technical Support at 1-800-444-4729. Outside the U.S., please contact your MEDIVATORS Distributor.



Manufactured in the USA by:

MEDIVATORS Inc. Headquarters
14605 28th Avenue North
Minneapolis, MN 55447 USA
Toll Free: +1.800.444.4729



MEDIVATORS BV
Sourethweg 11
6422PC Heerlen
The Netherlands
Tel: +31.45.5.471.471



MEDIVATORS Asia/Pacific Pte Ltd
1A International Business Park
#05-01 Singapore 609933
Tel: +65.6227.9698

MEDIVATORS Beijing Representative Office
Room 708, 7th Floor Kaiheng Center, Block B
No. 2 Chaoyangmennei Street
Dongcheng District, Beijing China 100010
Tel: +8610.6567.8446

www.medivators.com